

Surface Mount Schottky Barrier Rectifier

FEATURES

- Low power loss, high efficiency
- Ideal for automated placement
- Guardring for overvoltage protection
- High surge current capability
- Moisture sensitivity level: level 1, per J-STD-020
- Compliant to RoHS Directive 2011/65/EU and in accordance to WEEE 2002/96/EC
- Halogen-free according to IEC 61249-2-21 definition
- Available: Commercial or AEC-Q101-qualified



MECHANICAL DATA

Case: DO-214AC (SMA)

Molding compound, UL flammability classification rating 94V-0

Base P/N with suffix "H" on P/N - Automotive grade

Base P/N with suffix "G" on packing code - green compound (halogen-free)

Terminal: Matte tin plated leads, solderable per JESD22-B102

Meet JESD 201 class 1A whisker test

with suffix "H" on P/N meet JESD 201 class 2 whisker test

Polarity: Indicated by cathode band

Weight: 0.07 g (approximately)

DO-214AC (SMA)

MAXIMUM RATINGS AND ELECTRICAL CHARACTERISTICS (T _A =25°C unless otherwise noted)											
PARAMETER	SYMBOL	SK 32A	SK 33A	SK 34A	SK 35A	SK 36A	SK 39A	SK 310A	SK 315A	SK 320A	Unit
Maximum repetitive peak reverse voltage	V _{RRM}	20	30	40	50	60	90	100	150	200	V
Maximum RMS voltage	V _{RMS}	14	21	28	35	42	63	70	105	140	V
Maximum DC blocking voltage	V _{DC}	20	30	40	50	60	90	100	150	200	V
Maximum average forward rectified current	I _{F(AV)}	3									A
Peak forward surge current, 8.3 ms single half sine-wave superimposed on rated load	I _{FSM}	70									A
Maximum instantaneous forward voltage (Note 1) @ 3 A	V _F	0.55			0.72		0.85		0.95		V
Maximum reverse current @ rated VR T _J =25 °C T _J =100 °C T _J =125 °C	I _R	0.5			0.2		0.1			mA	
		10			5		-				
		-			10		0.5				
Voltage Rate of Change (Rated V _R)	dV/dt	10000									V/μs
Typical thermal resistance	R _{θJL}	25									°C/W
	R _{θJA}	66									
Operating junction temperature range	T _J	- 55 to +150									°C
Storage temperature range	T _{STG}	- 55 to +150									°C

Note 1: Pulse test with PW=300μs, 1% duty cycle

ORDERING INFORMATION					
PART NO.	PART NO. SUFFIX	PACKING CODE	PACKING CODE SUFFIX	PACKAGE	PACKING
SK3xxA (Note 1)	H	R3	G	SMA	1,800 / 7" Plastic reel
		R2		SMA	7,500 / 13" Paper reel
		M2		SMA	7,500 / 13" Plastic reel
		F3		Folded SMA	1,800 / 7" Plastic reel
		F2		Folded SMA	7,500 / 13" Paper reel
		F4		Folded SMA	7,500 / 13" Plastic reel
	N/A	E3		Clip SMA	1,800 / 7" Plastic reel
		E2		Clip SMA	7,500 / 13" Paper reel

Note 1: "xx" defines voltage from 20V (SK32A) to 200V (SK320A)

EXAMPLE					
PREFERRED P/N	PART NO.	PART NO. SUFFIX	PACKING CODE	PACKING CODE SUFFIX	DESCRIPTION
SK36A R3	SK36A		R3		
SK36A R3G	SK36A		R3	G	Green compound
SK36AHR3	SK36A	H	R3		Automotive grade

RATINGS AND CHARACTERISTICS CURVES

(T_A=25°C unless otherwise noted)

FIG. 1 FORWARD CURRENT DERATING CURVE

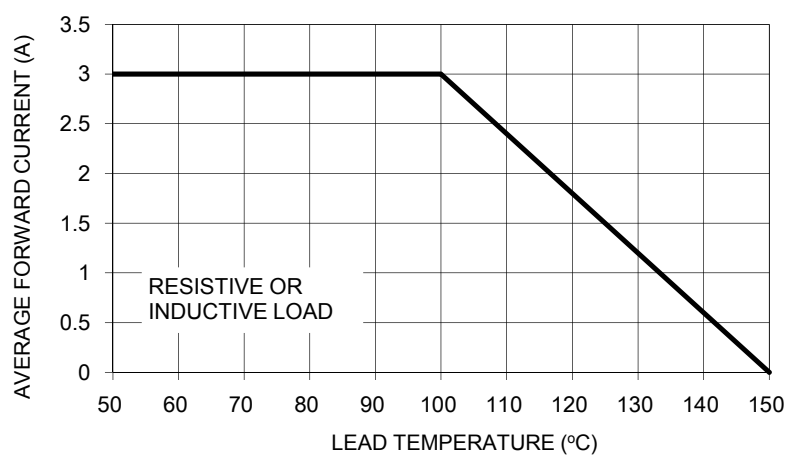

FIG. 2 MAXIMUM NON-REPETITIVE FORWARD SURGE CURRENT

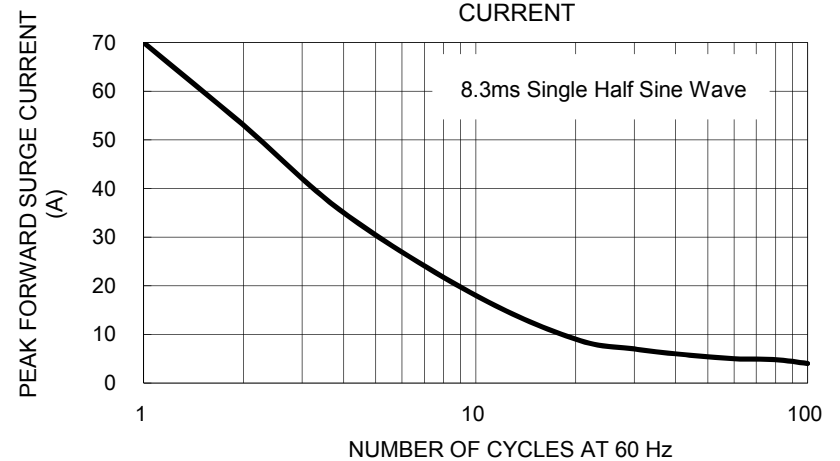

FIG. 3 TYPICAL FORWARD CHARACTERISTICS

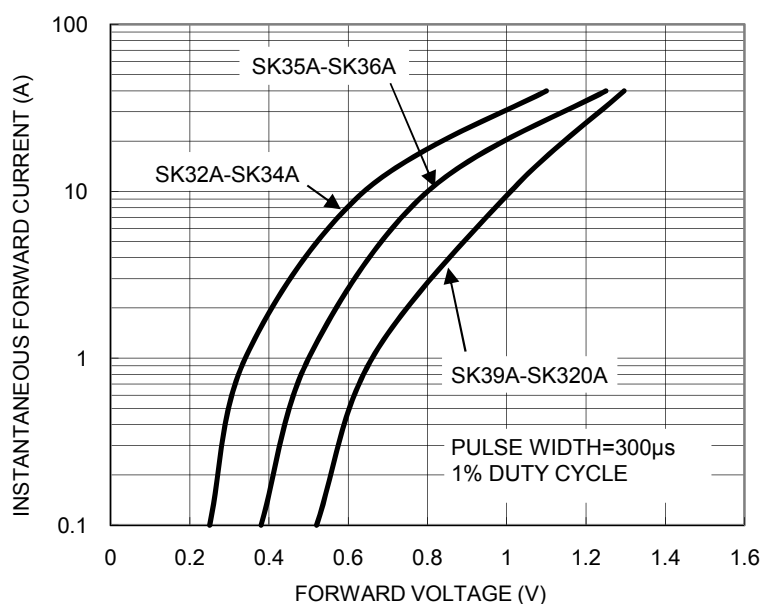

FIG. 4 TYPICAL REVERSE CHARACTERISTICS

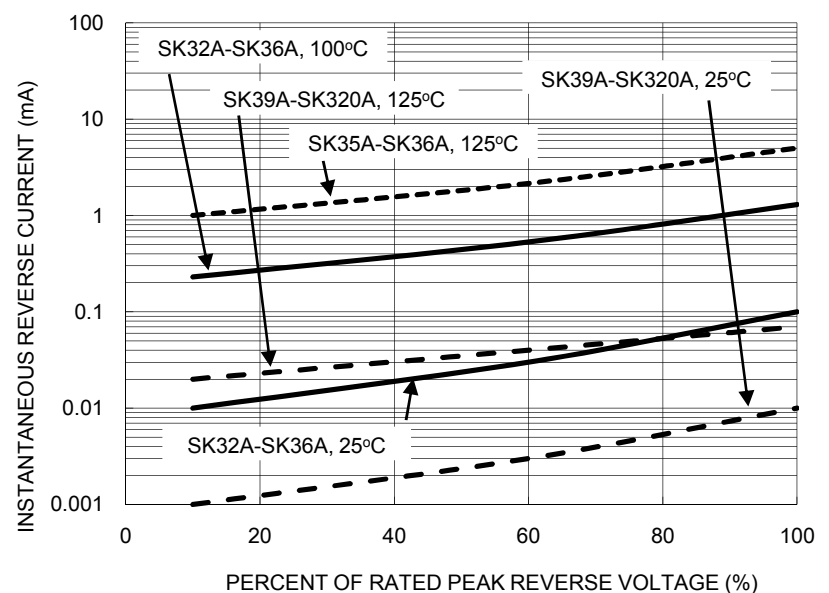

FIG. 5 TYPICAL JUNCTION CAPACITANCE

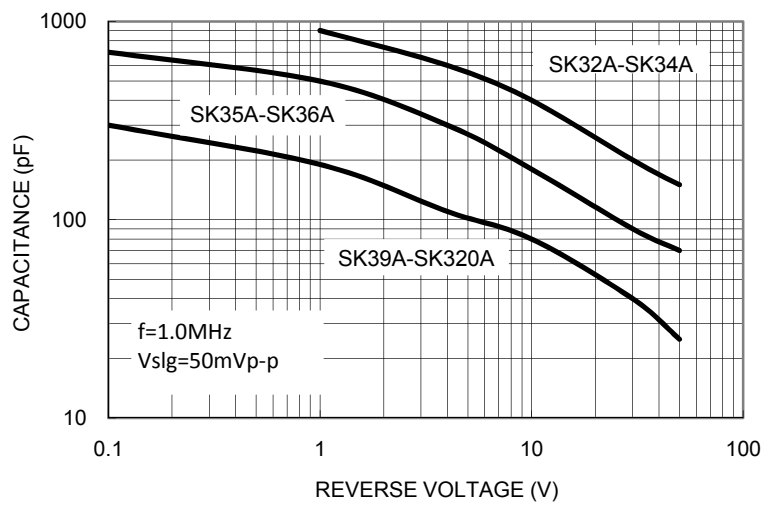
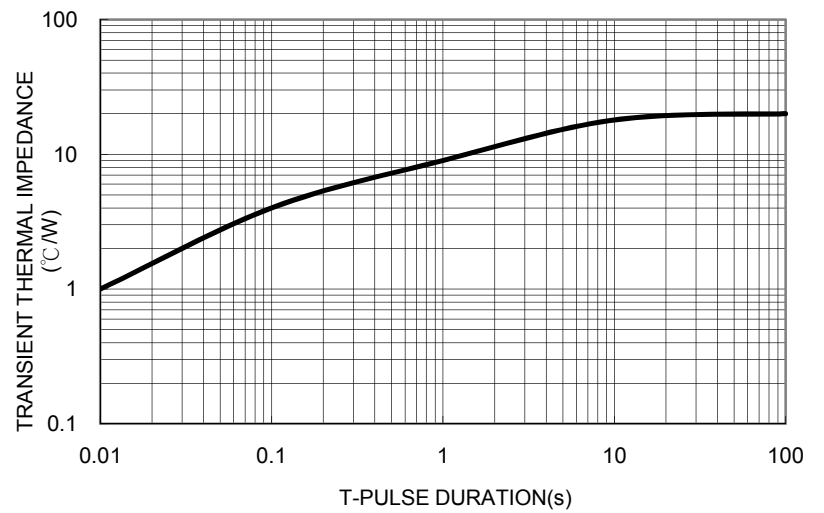
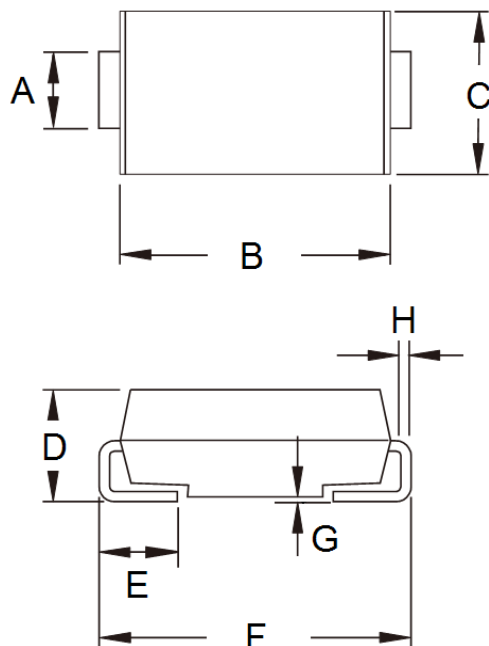

FIG. 6 TYPICAL TRANSIENT THERMAL IMPEDANCE



PACKAGE OUTLINE DIMENSIONS

DO-214AC (SMA)



DIM.	Unit (mm)		Unit (inch)	
	Min	Max	Min	Max
A	1.27	1.58	0.050	0.062
B	4.06	4.60	0.160	0.181
C	2.29	2.83	0.090	0.111
D	1.99	2.50	0.078	0.098
E	0.90	1.41	0.035	0.056
F	4.95	5.33	0.195	0.210
G	0.10	0.20	0.004	0.008
H	0.15	0.31	0.006	0.012

SUGGESTED PAD LAYOUT

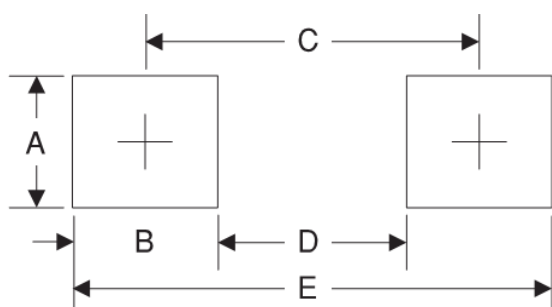

Symbol	Unit (mm)	Unit (inch)
A	1.68	0.066
B	1.52	0.060
C	3.93	0.155
D	2.41	0.095
E	5.45	0.215

MARKING DIAGRAM



P/N = Specific Device Code
 G = Green Compound
 YW = Date Code
 F = Factory Code

Notice

Specifications of the products displayed herein are subject to change without notice. TSC or anyone on its behalf, assumes no responsibility or liability for any errors inaccuracies.

Information contained herein is intended to provide a product description only. No license, express or implied, to any intellectual property rights is granted by this document. Except as provided in TSC's terms and conditions of sale for such products, TSC assumes no liability whatsoever, and disclaims any express or implied warranty, relating to sale and/or use of TSC products including liability or warranties relating to fitness for a particular purpose, merchantability, or infringement of any patent, copyright, or other intellectual property right.

The products shown herein are not designed for use in medical, life-saving, or life-sustaining applications. Customers using or selling these products for use in such applications do so at their own risk and agree to fully indemnify TSC for any damages resulting from such improper use or sale.